



CORDED HAND CONTROL
ON M103-86



FEATURES:

- BACK STYLE:** Bustle back with motorized adjustable headrest
- NAILHEAD:** Small size (*size/configuration shown standard*)
Rubbed Bronze and Antique Brass shown (*see samples for color selection*)
- WOOD FINISH:** Shagbark shown. Console features an optional wood tray (*see price list for wood finish color options*)
- DESIGN NOTE:** The Wedge (-53) does not feature a reversible cushion, but all other seat cushions in fabric may be flipped.
Activator switches on recliners with an arm feature a USB port.
The Motorized Reclining Armless Chair with Headrest (-86) features a corded hand control.
The Console features a pop-up charging station, cup holders, and drawer.

DIMENSIONS:

		Width	Depth	Height	Inside Width	Seat Height	Seat Depth	Arm Height	Overall Length Fully Reclined	Wall Clearance Needed	Footrest Extension
M103-84*	LAF Motorized Reclining Chair with Headrest	29	40	44	24	21	20	25	70	5	19
M103-85*	RAF Motorized Reclining Chair with Headrest	29	40	44	24	21	20	25	70	5	19
M103-36	Stationary Armless Chair	25	40	44	25	21	20	-	-	-	-
M103-86*	Motorized Reclining Armless Chair with Headrest	25	40	44	25	21	20	-	70	5	19
M103-53	Wedge	79	40	44	-	21	20	-	-	-	-
M103-71	Console	18	39	24	-	-	-	-	-	-	-
WC-101	Wood Console Tray	19	21	4	-	-	-	-	-	-	-
M103-83*	Motorized Reclining Chair with Headrest (<i>not shown</i>)	33	40	44	22	21	20	25	70	5	19
M103-87*	Motorized Swivel Glider Reclining Chair with Headrest (<i>not shown</i>)	33	40	44	22	21	20	25	65	12	17
M103-90*	Motorized Glider Reclining Chair with Headrest	33	40	44	22	21	20	25	65	12	17

*Battery Pack Available

All dimensions are approximate.
For more detailed information go to: www.smithbrothersfurniture.com

052024N

M103 RECLINING SECTIONAL WITH HEADREST

S|B MOTION

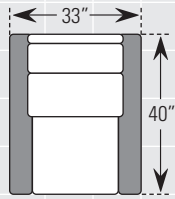

ITEM #83 **MOTORIZED** RECLINING CHAIR WITH HEADREST

ITEM #87 **MOTORIZED** SWIVEL GLIDER RECLINING CHAIR WITH HEADREST

ITEM #90 **MOTORIZED** GLIDER RECLINING CHAIR WITH HEADREST

INSIDE WIDTH: 22"

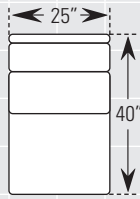

ITEM #36 **STATIONARY** ARMLESS CHAIR

ITEM #86 **MOTORIZED** ARMLESS RECLINING CHAIR WITH HEADREST

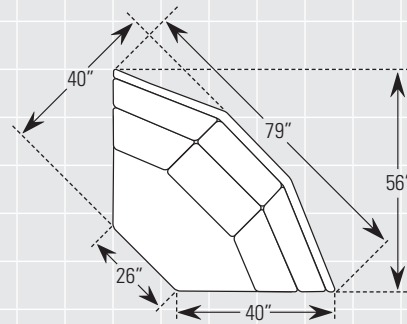

ITEM #53 **WEDGE**

WEB VERSION:
DIAGRAMS NOT TO SCALE

LAF = Left Arm Facing
RAF = Right Arm Facing

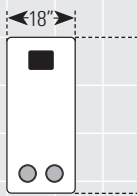

ITEM #71 **CONSOLE**
HEIGHT: 24"

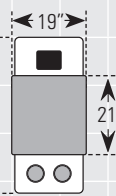

OPTION #WC-101 **WOOD CONSOLE TRAY**
SHOWN WITH CONSOLE (-71)
HEIGHT WITH TRAY: 25"

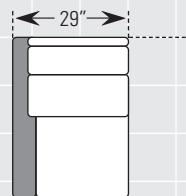

ITEM #84 **LAF** **MOTORIZED** RECLINING CHAIR WITH HEADREST
INSIDE WIDTH: 24"

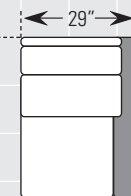

ITEM #85 **RAF** **MOTORIZED** RECLINING CHAIR WITH HEADREST
INSIDE WIDTH: 24"



EXAMPLE COMBINATIONS Example diagrams are not to scale.

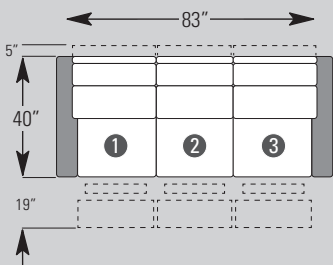

3-CUSHION RECLINING SOFA:

- 1) M103-84 LAF MOTORIZED RECLINING CHAIR WITH HEADREST
- 2) M103-86 MOTORIZED ARMLESS RECLINING CHAIR WITH HEADREST
- 3) M103-85 RAF MOTORIZED RECLINING CHAIR WITH HEADREST

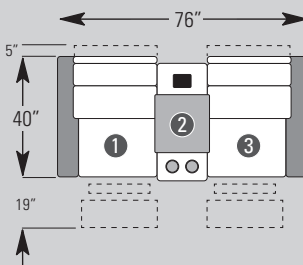

RECLINING LOVESEAT WITH CONSOLE:

- 1) M103-84 LAF MOTORIZED RECLINING CHAIR WITH HEADREST
- 2) M103-71 CONSOLE WITH OPTIONAL WC-101 WOOD CONSOLE TRAY
- 3) M103-85 RAF MOTORIZED RECLINING CHAIR WITH HEADREST

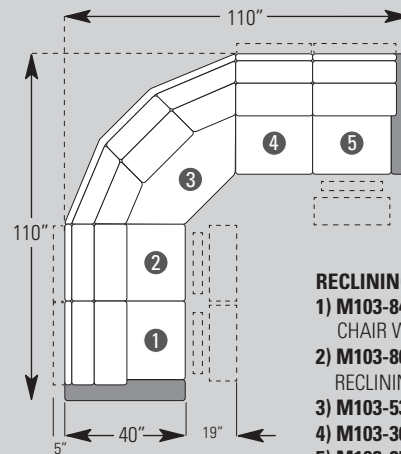

*The Wedge (-53) must be attached to a Stationary Chair (-36) on at least one end so that recliner footrests can all open at the same time without interference.

RECLINING SECTIONAL WITH WEDGE:

- 1) M103-84 LAF MOTORIZED RECLINING CHAIR WITH HEADREST
- 2) M103-86 MOTORIZED ARMLESS RECLINING CHAIR WITH HEADREST
- 3) M103-53 WEDGE*
- 4) M103-36 STATIONARY ARMLESS CHAIR
- 5) M103-85 RAF MOTORIZED RECLINING CHAIR WITH HEADREST

M103 RECLINING SECTIONAL WITH HEADREST

Choose from a variety of different pieces to create an infinite number of combinations. Each piece is a single seat, and our innovative bracket system allows you to position them in any configuration; from a simple reclining sofa to a custom-sized sectional. This bracket system keeps the units together and prevents shifting or separating. Note that armless sides have exposed connector brackets, so all configurations must have an arm at both the left and right ends.

All dimensions are approximate and subject to change without notice. See www.smithbrothersfurniture.com for more information.

COMMON DIMENSIONS

These dimensions are the same for all pieces in this group unless otherwise noted.

OVERALL HEIGHT	44"
SEAT HEIGHT	21"
SEAT DEPTH	20"
ARM HEIGHT	25"
RECLINER FOOTREST EXTENSION	19"
MOTORIZED GLIDING RECLINERS WITH HEADREST (-87, 90)	17"
WALL CLEARANCE NEEDED	5"
MOTORIZED GLIDING RECLINERS WITH HEADREST (-87, 90)	12"
OVERALL LENGTH FULLY RECLINED	70"
MOTORIZED GLIDING RECLINERS WITH HEADREST (-87, 90)	65"



M103

FABRIC
style



FEATURES:

BACK STYLE: Bustle back with motorized adjustable headrest

NAILHEAD: Small size (size/configuration shown standard)
Black Pearl (see samples for color selection)

DESIGN NOTE: Seat cushion may be flipped.
Activator switches on recliners feature a USB port.

DIMENSIONS:

		Width	Depth	Height	Inside Width	Seat Height	Seat Depth	Arm Height	Overall Length Fully Reclined	Wall Clearance Needed	Footrest Extension
M103-83*	Motorized Reclining Chair with Headrest	33	40	44	22	21	20	25	70	5	19
M103-87*	Motorized Swivel Glider Reclining Chair with Headrest	33	40	44	22	21	20	25	65	12	17
► M103-90*	Motorized Glider Reclining Chair with Headrest (shown)	33	40	44	22	21	20	25	65	12	17

*Battery Pack Available

All dimensions are approximate.
For more detailed information go to: www.smithbrothersfurniture.com





M103

LEATHER
style



FEATURES:

BACK STYLE: Bustle back with motorized adjustable headrest

NAILHEAD: Small size (size/configuration shown standard)
Antique Brass (see samples for color selection)

DESIGN NOTE: Activator switches on recliners feature a USB port.

DIMENSIONS:

		Width	Depth	Height	Inside Width	Seat Height	Seat Depth	Arm Height	Overall Length Fully Reclined	Wall Clearance Needed	Footrest Extension
M103-83*	Motorized Reclining Chair with Headrest	33	40	44	22	21	20	25	70	5	19
M103-87*	Motorized Swivel Glider Reclining Chair with Headrest	33	40	44	22	21	20	25	65	12	17
► M103-90*	Motorized Glider Reclining Chair with Headrest (shown)	33	40	44	22	21	20	25	65	12	17

*Battery Pack Available



All dimensions are approximate.
For more detailed information go to: www.smithbrothersfurniture.com

092024N